

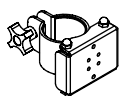

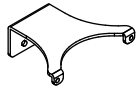

Item #	Illustration	Part Number & Description	Qty.
1		<b>94-00135-000</b> Easy Mount Post Clamp	1
2		83-02000-141 Handle Base	1
3		83-28000-025 Pull-Handle 4"	1
4		83-28001-047 8-32 x 1/2" Phillips Pan-Head Screw	2
5		83-28001-004 M5 x 8mm Metric Slot Head Machine Screw	2



Assembly View

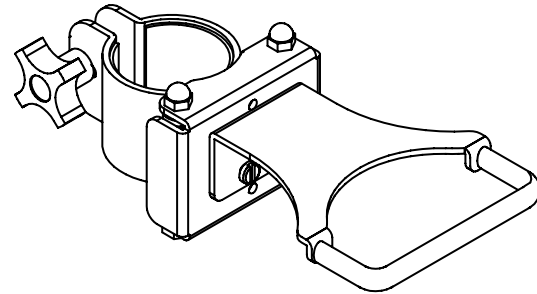
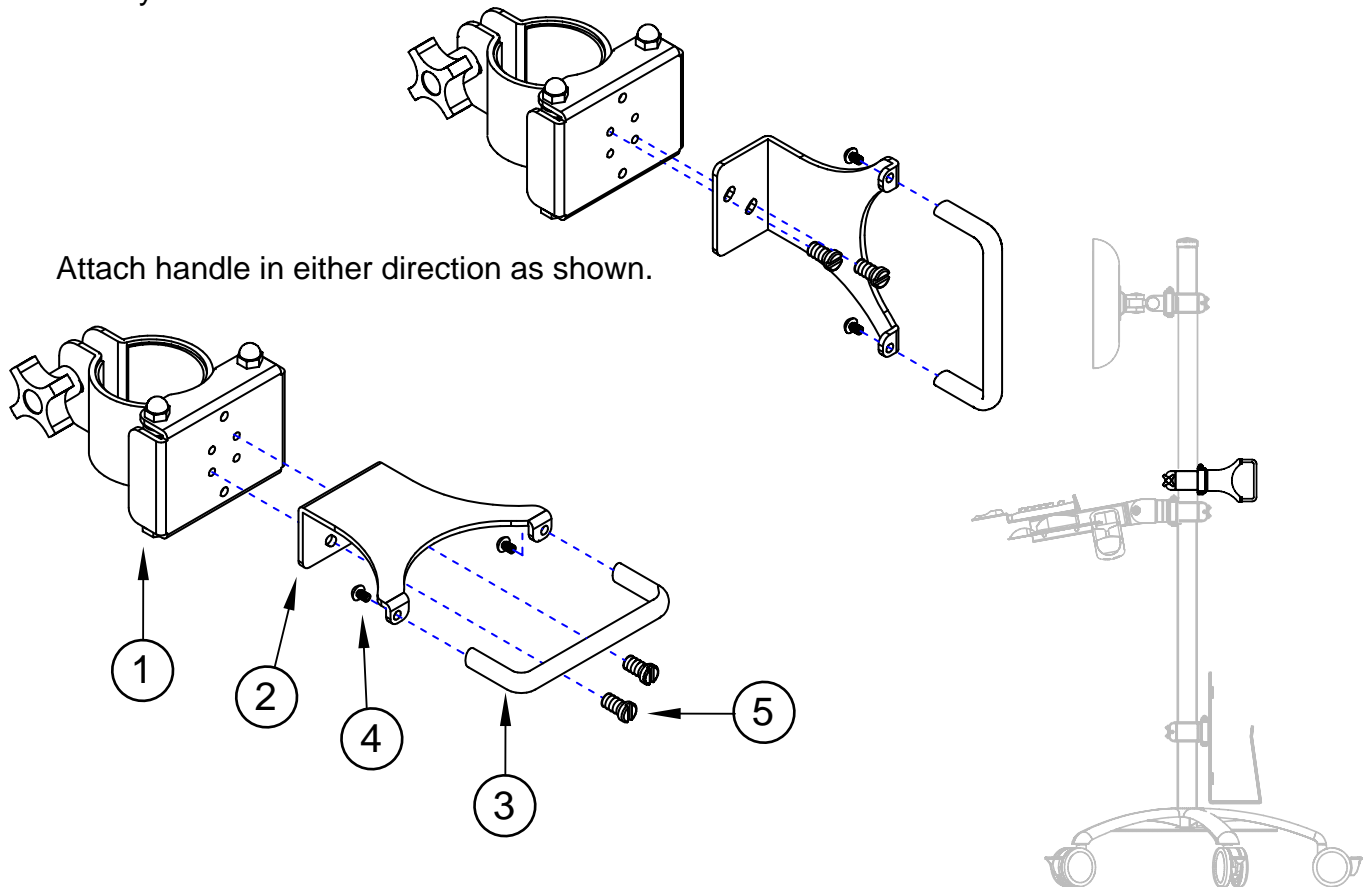

UNLESS OTHERWISE SPECIFIED  
 DIMENSIONS ARE IN INCHES  
 TOLERANCES  
 2 PL DECIMALS ± .01  
 3 PL DECIMALS ± .005

NEXT ASS'Y:

DATE: