











Item #	Illustration	Part Number & Description	Qty.	Item #	Illustration	Part Number & Description	Qty.
1		94-00135-000 Easy Mount Post Clamp	1	6		100mm Plate 15-00090-100 100mm Mounting Plate	2
2		15-00090-078 Adapter For Duo Command Deskmount	1	7		83-28002-097 Weld Nut 1/4-20 Thread	4
3		15-00092-078 Mounting Plate For Duo Command Deskmount	1	8		83-28001-140 1/4-20 x 3/8" Socket Head Cap Screw Black	4
4	 <i>Includes hardware</i>	PA-01T-24 15-HE501-024 Flat Panel Display Track 24"	1	9		83-28001-009 M6 x 8mm Metric Slot Head Screw	2
5	 <i>Includes hardware</i>	LA-17P 15-00048-17P Flat Panel Monitor Mount	2	10		83-28004-015 #8 Split Lock Washer Zinc Plated	4
				11		83-28002-058 8-32 Hex Nut	4

Assembly View



Assembled View

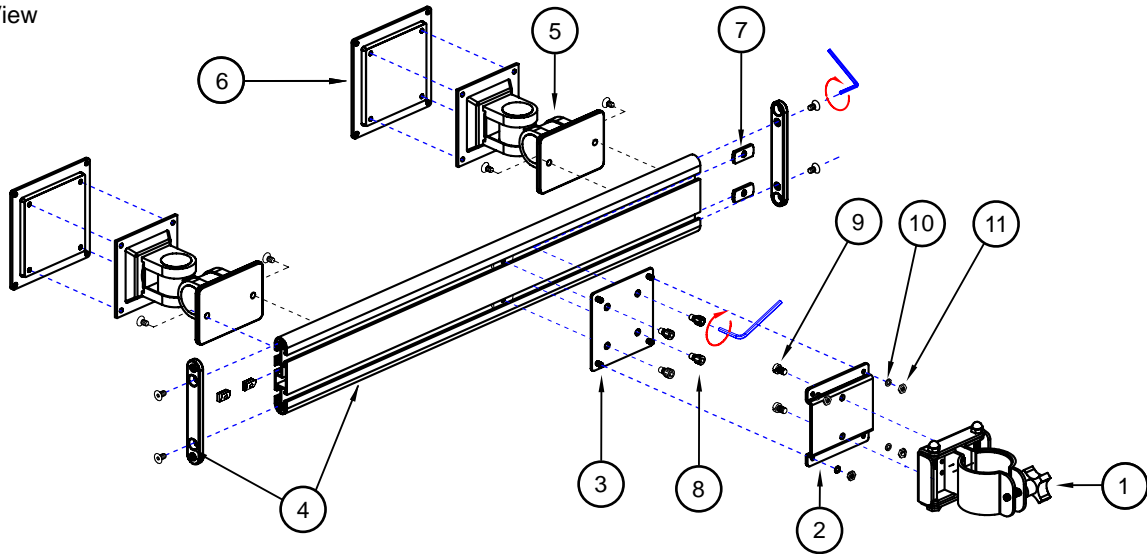
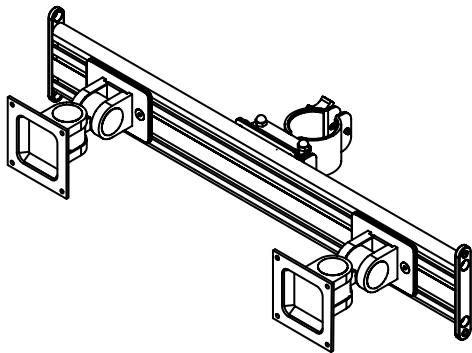

Plan View

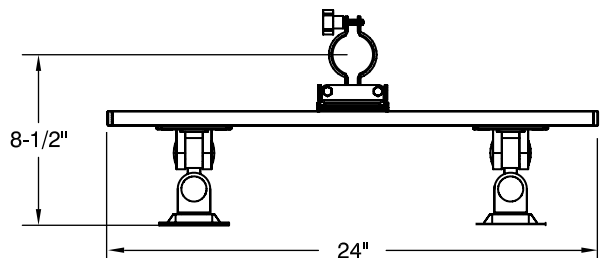

UNLESS OTHERWISE SPECIFIED
 DIMENSIONS ARE IN INCHES
 TOLERANCES
 2 PL DECIMALS ± .01
 3 PL DECIMALS ± .005

NEXT ASS'Y:

DATE:

hergo