

Wall Mount Cabinet
 (Fan Sold Separately)

Back View

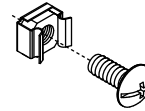

Includes 10 Screws & Cage-Nuts
 for mounting equipment

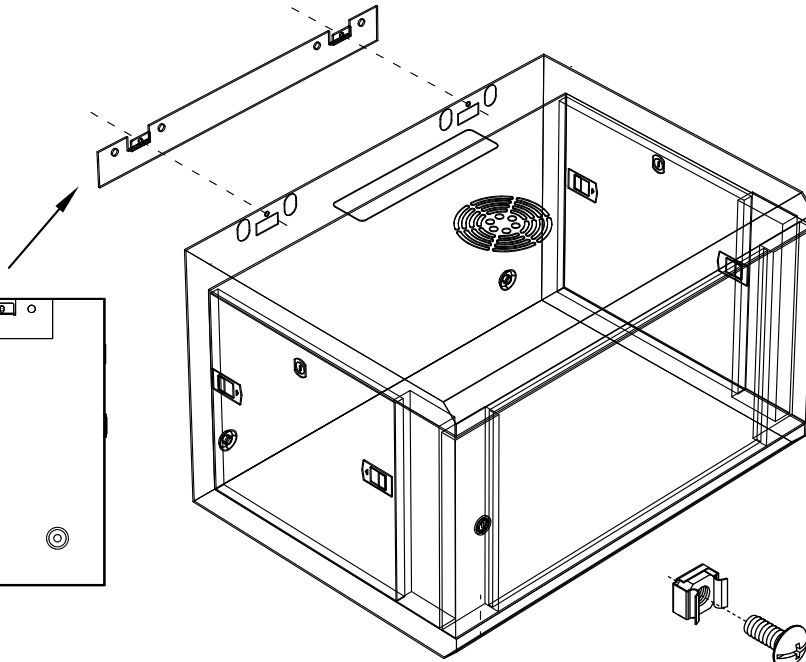
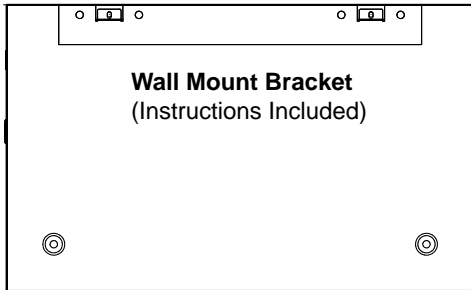
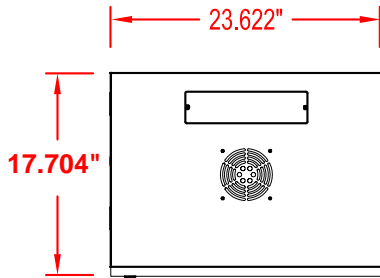

Plan View

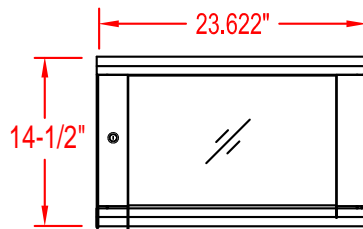

Front View

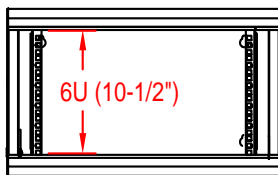
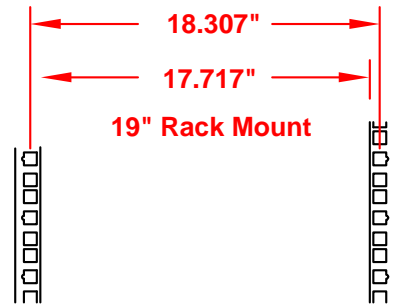

**Front View
 Without Doors**

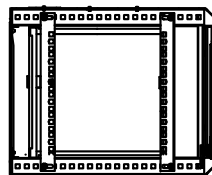

Side View Section

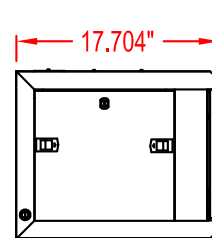

Side View

UNLESS OTHERWISE SPECIFIED
 DIMENSIONS ARE IN INCHES
 TOLERANCES
 2 PL DECIMALS ± .01
 3 PL DECIMALS ± .005

NEXT ASS'Y:

DATE: