

Item #	Illustration	Part Number & Description	QTY,	Assembly View
1		LA-514 15-HE514-000 Post Connection Mount	1	
2		LA-511 15-HE511-000 Universal Joint LCD Mount Includes 100mm Mounting Plate (15-00090-100)	1	
3		LA-512 15-HE512-000 7" Extender Arm	1	

INCLUDES HARDWARE AND TOOLS AS SHOWN ABOVE

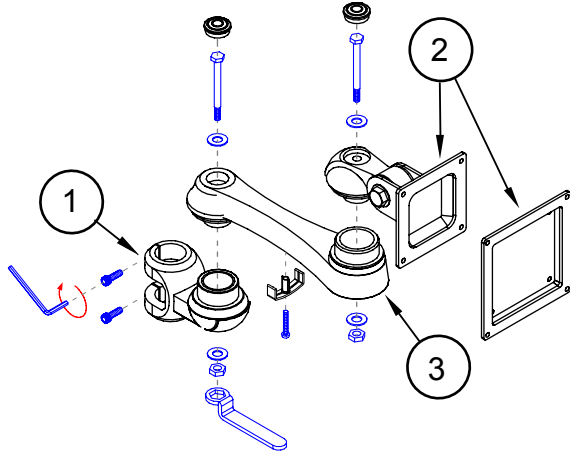
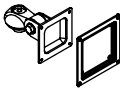
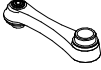
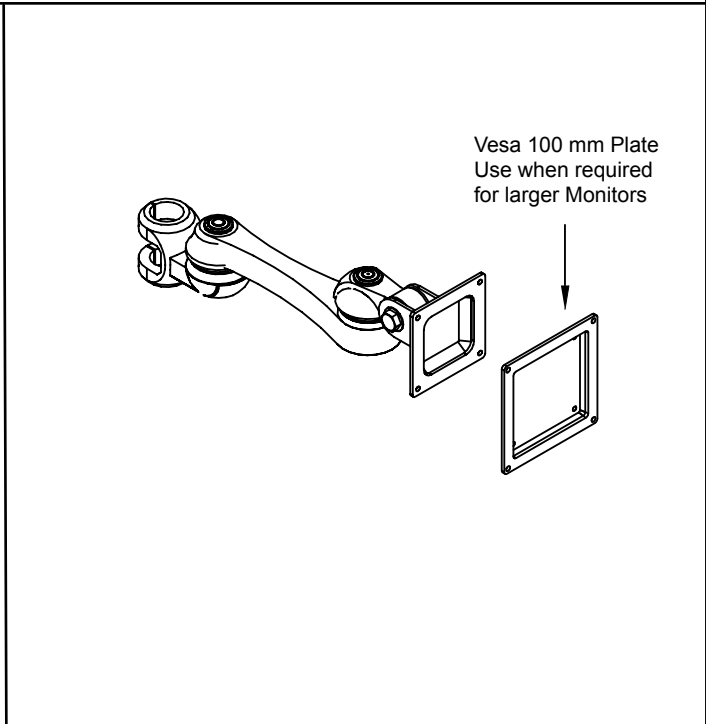
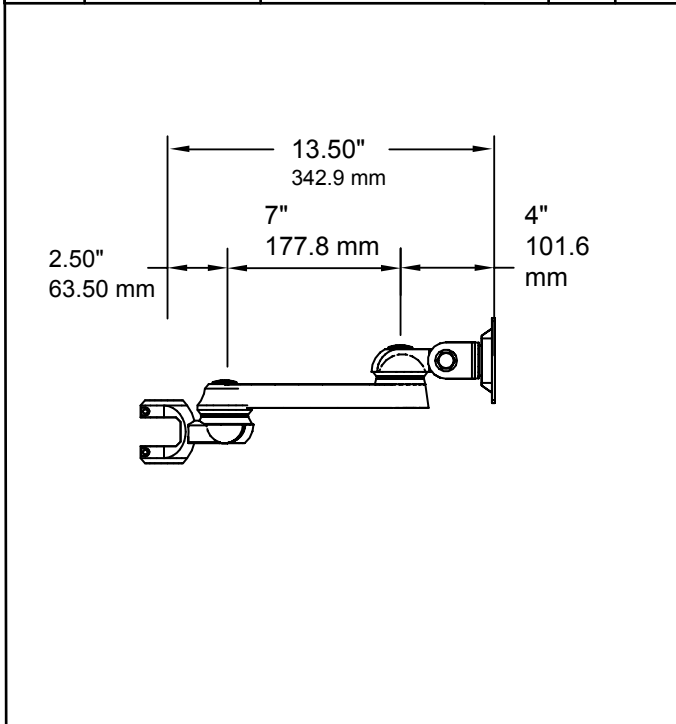

<small>UNLESS OTHERWISE SPECIFIED DIMENSIONS ARE IN INCHES TOLERANCES 2 PL DECIMALS ± .01 3 PL DECIMALS ± .005</small>	NEXT ASS'Y:	hergo
	Configuration 95-HE502-035	
	DATE: 05/20/04	