

Item #	Illustration	Part Number & Description	QTY,
1		LA-501A 15-HE501-014 Post Assembly for LCD	1
2		LA-201S 15-HE501-018 Standard Desk Clamp	1
3		LA-514 15-HE514-000 Post Connection Mount	1
4		LA-511 15-HE511-000 Universal Joint LCD Mount Includes 100mm Mounting Plate (15-00090-100)	1
5		LA-513 15-HE513-000 10" Extender Arm	1

Assembly View

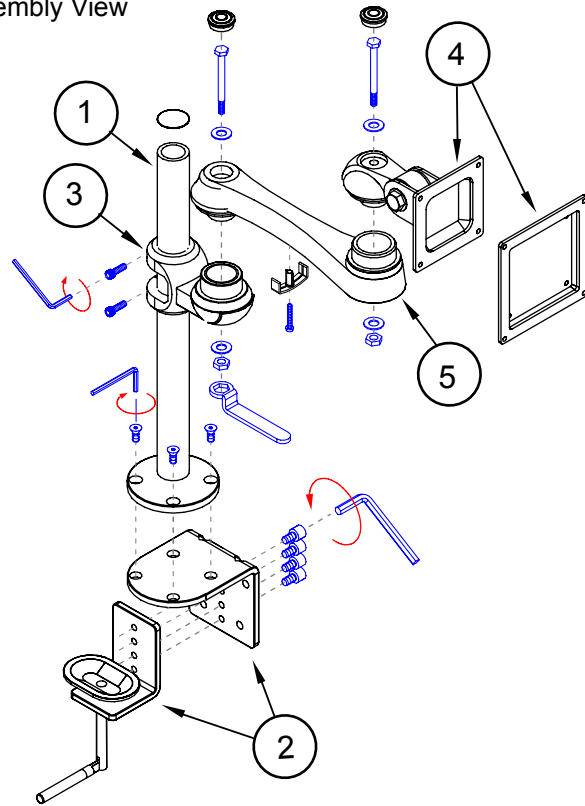

INCLUDES HARDWARE AND TOOLS AS SHOWN ABOVE

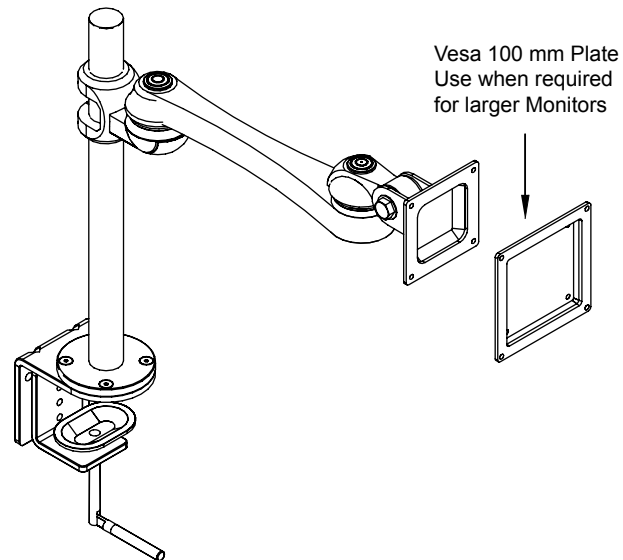
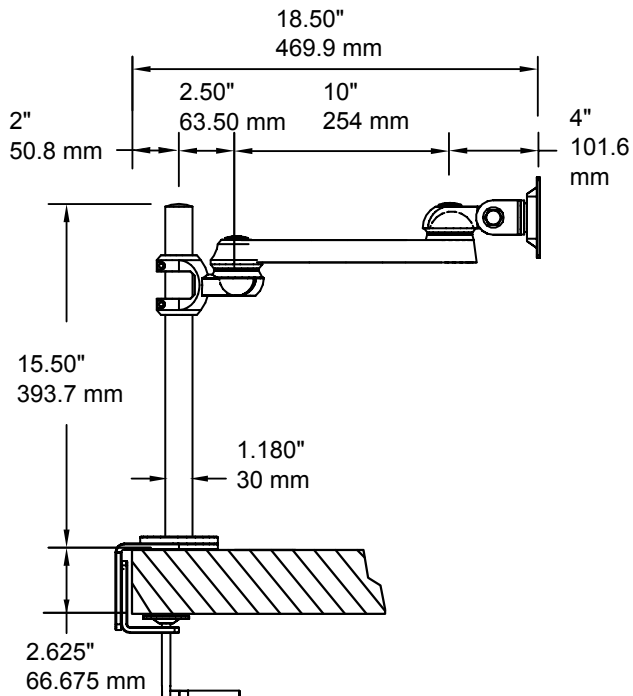

UNLESS OTHERWISE SPECIFIED
 DIMENSIONS ARE IN INCHES
 TOLERANCES
 2 PL DECIMALS ± .01
 3 PL DECIMALS ± .005

NEXT ASS'Y:

Configuration 95-HE502-040

DATE: 05/20/04